

PPL™ 108 Series

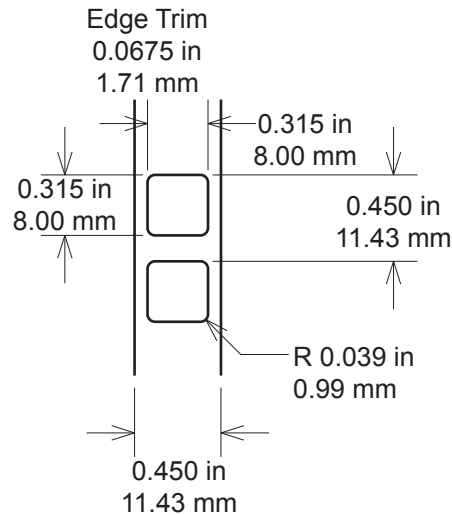

Type of bar code required.

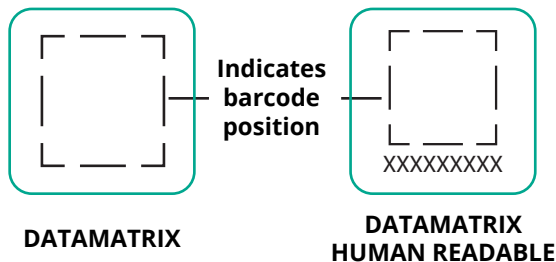

NOT TO SCALE

Proprietary - Property of IDENTCO

Standard Tolerances	Label dimension	± .010" (.254 mm)
Label tolerances are as stated unless otherwise noted.	Edge trim/web size	± .03125" (.79375 mm)

Revisions

REV	Date	By	Description
A	01/30/18	IA	Released
A	01/30/18	PPE	Released

NOTES:

- (1) All labels supplied on REEL-E™
- (2) Standard Qty/Roll = 10,000 pieces
- (3) 1 foot leader
- (4) 1 foot trailer

Part Number	Material Description	TTRR™	USA • EU • IA • IM
PPL-108-416FL-10	Economy gloss white polyimide	B,D	● ● ● ●
PPL-108-403FL-10	Gloss white polyimide	B,D	● ● ● ●
PPL-108-433FL-10	Hi-performance gloss white polyimide	CR	● ● ● ●
PPL-108-451FL-10	ESD semi-gloss white polyimide	B,D	● ● ● ●
PPL-108-481FL-10	Low profile gloss white polyimide	B,D	● ● ● ●



Labels for Life.

PPL™ 108 Series

Size: 0.315" x 0.315" (8.00 mm x 8.00 mm)