

TTL™ 10 Series

Revisions			
REV	Date	By	Description
A	07/16/18	IA	Released
A	07/16/18	PPE	Released

Part Number	Material Description	Ribbon
TTL-10	Thermal Transfer Matte White Paper with Permanent Adhesive	TTR

Part Number	Material Description	Ribbon
TTL-10P	Thermal Transfer Matte White Paper with Permanent Adhesive	TTR

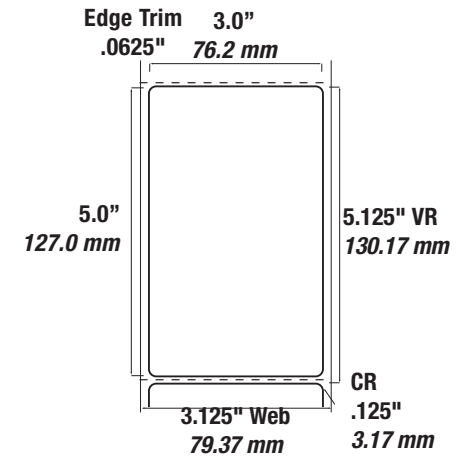
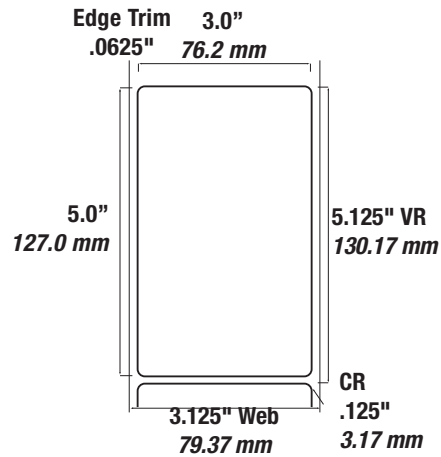

NOT TO SCALE

Proprietary - Property of IDENTCO

Standard Tolerances	Label dimension	± .010" (.254 mm)
Label tolerances are as stated unless otherwise noted.	Edge trim/web size	± .03125" (.79375 mm)



TTL™ 10 Series

Size: 3.0" x 5.0" (76.20 mm x 127.00mm)