

TTL™ 5 Series

Revisions			
REV	Date	By	Description
A	07/16/18	IA	Released
A	07/16/18	PPE	Released

Part Number	Material Description	Ribbon
TTL-5	Thermal Transfer Matte White Paper with Permanent Adhesive	TTR

Part Number	Material Description	Ribbon
TTL-5P	Thermal Transfer Matte White Paper with Permanent Adhesive	TTR

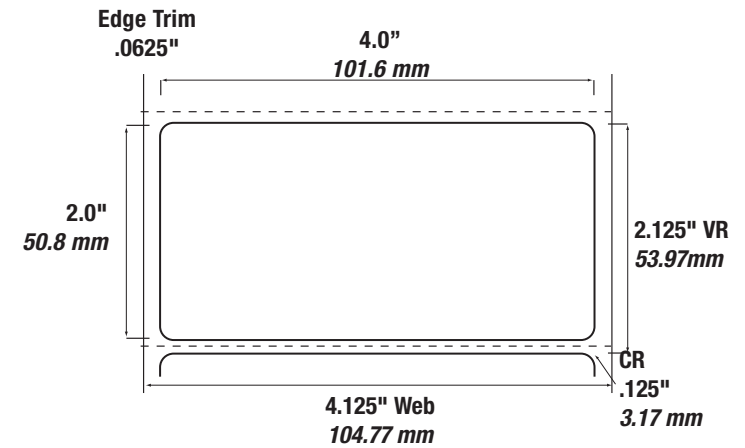
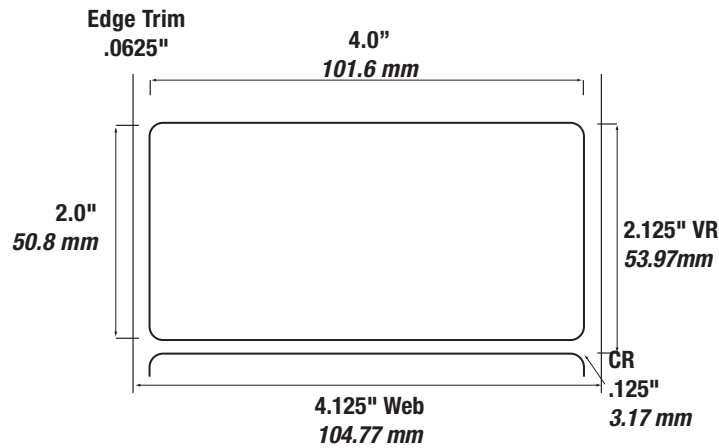

NOT TO SCALE

Proprietary - Property of IDENTCO

Standard Tolerances	Label dimension	± .010" (.254 mm)
Label tolerances are as stated unless otherwise noted.	Edge trim/web size	± .03125" (.79375 mm)



Labels for Life.

TTL™ 5 Series

Size: 4.0" x 2.0" (101.60 mm x 50.80mm)