

TTL™ 9 Series

Revisions

REV	Date	By	Description
A	07/16/18	IA	Released
A	07/16/18	PPE	Released

Part Number	Material Description	Ribbon
TTL-9P	Thermal Transfer Matte White Paper with Permanent Adhesive	TTR

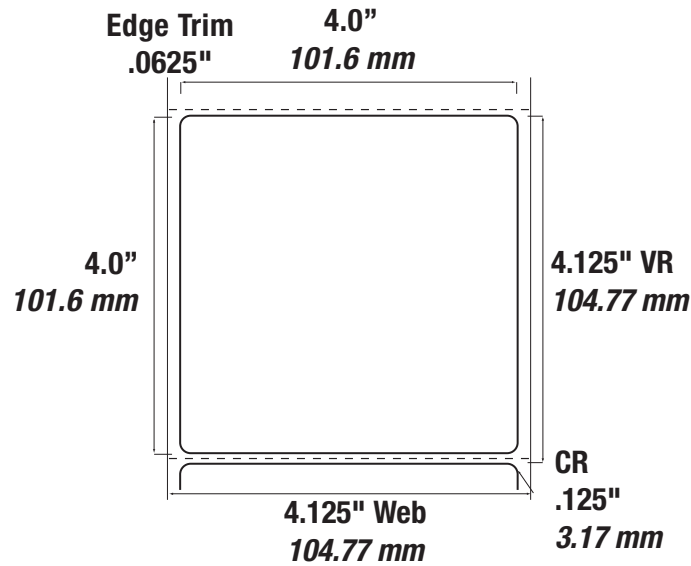

NOT TO SCALE

Proprietary - Property of IDENTCO

Standard Tolerances	Label dimension	± .010" (.254 mm)
Label tolerances are as stated unless otherwise noted.	Edge trim/web size	± .03125" (.79375 mm)



Labels for Life.

TTL™ 9 Series

Size: 4.0" x 4.0" (101.6 mm x 101.6mm)