

TTL™ 144 Series

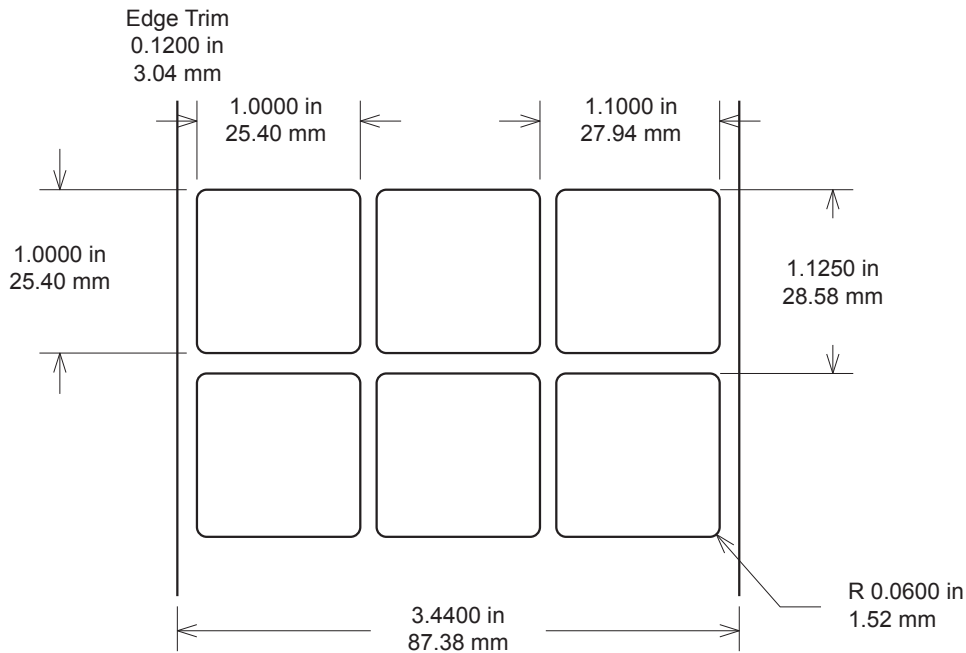

Revisions			
REV	Date	By	Description
A	01/30/18	IA	Released
A	01/30/18	PPE	Released
B	06/27/18	IA	REMOVE 490,491,492,493
B	06/27/18	PPE	REMOVE 490,491,492,493
C	02/24/23	IA	REMOVE 417, 482 ADD 413, 748, 770
C	02/24/23	PPE	REMOVE 417, 482 ADD 413, 748, 770

Part Number	Material Description	TTRR™	USA • EU • IM
TTL144-403-10	Gloss white polyimide	B,D	● ● ●
TTL144-403GR-10	Gloss green polyimide	B,D	● ● ●
TTL144-411-10	Matte tan polyimide	AK	● ● ●
TTL144-413-10	Hi-performance gloss white polyimide	CR,D	● ● ●
TTL144-416-10	Economy gloss white polyimide	B,D	● ● ●
TTL144-433-10	Hi-performance gloss white polyimide	CR,D	● ● ●
TTL144-451-10	ESD semi-gloss white polyimide	B,D	● ● ●
TTL144-481-10	Low profile gloss white polyimide	B,D	● ● ●
TTL144-700-10	Gloss white polyester	B,D	● ● ●
TTL144-748-10	Matte white polyester	B,D	● ● ●
TTL144-770-10	ESD gloss white polyester	B,D	● ● ●

NOT TO SCALE

Proprietary - Property of IDENTCO

Standard Tolerances	Label dimension	± .010" (.254 mm)
Label tolerances are as stated unless otherwise noted.	Edge trim/web size	± .03125" (.79375 mm)



Labels for Life.

TTL™ 144 Series

Size: 1.0" x 1.0" (25.40 mm x 25.40mm)